



Burner Systems:

- G8E-16/20/24(P)
- G8E-16/20/24-12(M)(P)
(20,000 BTU)
- G8E-16/20/24R(P)
- G8E-16/20/24R-12(M)(P)
(9,500 BTU)

Log Sets:

VO8E-(16, 20, 24) Valley Oak



24" VO8E log set shown

DESIGN CERTIFIED to standards:

- Unvented Room Heater
ANSI Z21.11.2
and
- Vented Decorative Appliance
ANSI Z21.60

G8E UNVENTED GAS LOG SETS

INSTALLER: Leave this manual with the appliance
CONSUMER: Retain this manual for future reference

Installation and service must be performed by a qualified professional installer, service agency, or the gas supplier.

▲ WARNING: If the information in this manual is not followed exactly, a fire or explosion may result, causing property damage, personal injury, or loss of life.

Do not store or use gasoline or other flammable vapors and liquids in the vicinity of this or any other appliance.

WHAT TO DO IF YOU SMELL GAS:

- Open a window.
- Do not try to light any appliance.
- Do not touch any electrical switch; do not use any phone in your building.
- Immediately call your gas supplier from a neighbor's phone. Follow the gas supplier's instructions.
- If you cannot reach your gas supplier, call the fire department.

It is imperative that you maintain your unvented gas appliance by having it cleaned and serviced regularly. See pages 11, 23-26 for details.

Important

Read these instructions carefully and completely before starting installation of the burner system.

This appliance may be installed in an aftermarket, permanently located, manufactured (mobile) home where not prohibited by local codes.

This appliance is only for use with the type of gas indicated on the rating plate. This appliance is not convertible for use with other gasses.

This is an **UNVENTED** gas-fired heater. It uses air (oxygen) from the room in which it is installed. Provisions for adequate combustion and ventilation air **MUST** be provided. See section entitled **VENTILATION AND CONFINED SPACE INFORMATION**.

This appliance is designed as an **attended appliance**. Adults must be present when the unit is operating. Do not leave this unit burning when unattended or while anyone is sleeping.

Installation, service, and the provisions for combustion and ventilation air **MUST** conform with local codes and with the *National Fuel Gas Code*, ANSI Z223.1/ NFPA 54, or the *CSA B149.1, Natural Gas And Propane Installation Code*.

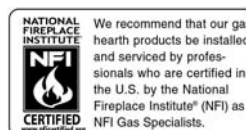

CONTENTS

GETTING STARTED

SPECIFICATIONS AND REQUIREMENTS	3
IMPORTANT SAFETY INFORMATION	4
VENTILATION AND CONFINED SPACE SAFETY INFORMATION	5
MINIMUM CLEARANCES TO COMBUSTIBLES	6
PRE-INSTALLATION AND FIREPLACE PREPARATION SAFETY	8
INSTALLATION SAFETY INFORMATION	9
OPERATIONAL SAFETY INFORMATION	10
CLEANING AND SERVICING IMPORTANT INFORMATION	11
G8E BURNER PARTS LIST - MANUAL SERIES	12
G8E BURNER PARTS LIST - 12 SERIES	13

INSTALLATION

WHEN USED AS A VENTED DECORATIVE APPLIANCE (PER ANSI Z21.60)	14
DAMPER CLAMP INSTRUCTIONS (WHEN USE AS A VENTED DECORATIVE APPLIANCE)	14
INSTALLATION	14
<i>INSTALL BURNER</i>	15
<i>INSTALL REMOTE - 12 MODELS ONLY (if equipped)</i>	15
<i>CONTROL SETTINGS</i>	16
<i>LIGHTING TEST</i>	16
<i>GAS PRESSURE</i>	16
<i>SECURE BURNER TO FLOOR</i>	16
<i>INSTALL DECOR PANEL</i>	16
<i>LAVA GRANULES (OPTIONAL)</i>	17
<i>LOG SET PLACEMENT</i>	18
INSTALL/REPLACE BATTERIES (IF APPLICABLE)	19
<i>REMOTE TRANSMITTER BATTERY</i>	19
<i>REMOTE RECEIVER BATTERIES</i>	19
CHECK GAS PRESSURE	20
<i>12 VALVE</i>	20
<i>MANUAL VALVE</i>	20

USE, CARE, & SERVICE

LIGHTING INSTRUCTIONS - MANUAL VALVE	21
LIGHTING INSTRUCTIONS - SERIES 12 VALVE	22
CLEANING AND SERVICING SAFETY INFORMATION	23
CLEANING AND SERVICING	24
<i>TO CLEAN THE BURNER SYSTEM</i>	24
<i>CLEANING AND SERVICING THE ODS PILOT</i>	24
<i>SYNCING THE REMOTE SYSTEM (if equipped)</i>	25
OPERATING THE BURNER SYSTEM	25
CHECKING THE ODS PILOT FLAME APPEARANCE	26
TROUBLESHOOTING	27
WARRANTY	30

SPECIFICATIONS AND REQUIREMENTS

WARNING: This appliance is for installation only in a:

1. Solid-fuel-burning masonry or UL-127 factory-built fireplace, or
2. Listed ventless firebox enclosure.

It has been designed certified for these installations. Exception: DO NOT install this appliance in a factory built fireplace that includes instructions stating it has not been tested or should not be used with unvented burner systems.

Note: Installation in any other fireplace is prohibited and will void any approvals and warranties.

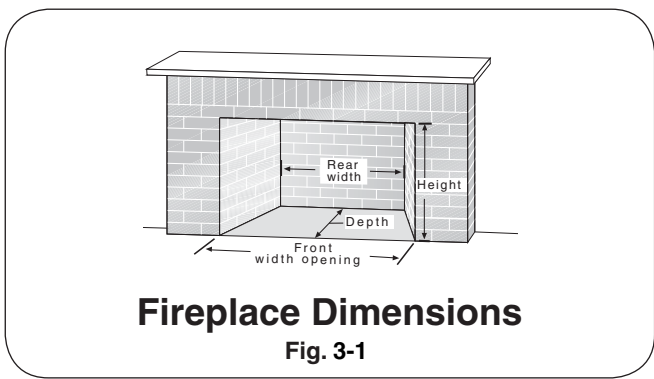

Any installation of this appliance is subject to minimum fireplace size requirements below:

Burner Model	Minimum Fireplace Size (refer to Fig. 3-1)				BTU Rating			
	Width		Depth	Height	Nat. Gas		L.P. Gas	
	Front	Rear*			Standard	Reduced	Standard	Reduced
G8E-16/20/24 (16" log set)	17"	13"	9 1/2"	17"	20k	9.5k	20k	9.5k
G8E-16/20/24 (20" log set)	21"	13"	9 1/2"	17"	20k	9.5k	20k	9.5k
G8E-16/20/24 (24" log set)	26"	13"	9 1/2"	17"	20k	9.5k	20k	9.5k

* based on minimum depth

This burner system is equipped with an Oxygen Depletion Sensor (ODS) safety pilot system. The ODS senses the amount of oxygen available in the room and shuts the burner system off before the oxygen level drops below 18%. The pilot can only be relit when fresh air is available. **This may require opening a window or a door to another room or cracking the damper open slightly.**

Observing minimum fireplace dimensions and centering the appliance in the fireplace will ensure adequate clearance for operation and servicing. It may be necessary to disconnect the unit for some types of service.

This burner system has been certified to two standards:
UNVENTED ROOM HEATER-ANSI Z21.11.2
VENTED DECORATIVE APPLIANCE-ANSI Z21.60

Check local or state codes to determine if vent-free heaters are permitted in your locality before you install this burner system as a vent-free appliance. If not permitted, you may install and operate this burner system as a vented appliance.

This unit may not be installed in a vented fireplace with a chimney of less than 15 feet in height.

Minimum Permanent Chimney Vent Opening in sq. in. (when used as a vented appliance)		
Table 3-1	Factory built fireplaces*	
Chimney Height	Standard Models	Reduced Models
15'	9	5
20'	8	4
25'	7	4
30'	6	3

*For masonry-built fireplaces, add 10 sq. in. to amount shown.

Specification	Value	Qty.
Remote receiver battery type	AA battery	4
Remote transmitter battery type	12V battery	1

Table 3-2 - Technical Data (if applicable)

IMPORTANT SAFETY INFORMATION

UNVENTED ROOM HEATER GENERAL SAFETY INFORMATION

A. **WARNING: CARBON MONOXIDE POISONING MAY LEAD TO DEATH.**

Early signs of carbon monoxide poisoning are similar to the flu, with headaches, dizziness, and/or nausea. If you have these signs, the gas appliance may not be installed correctly, or may not be working properly. **GET FRESH AIR AT ONCE! STOP USING THE APPLIANCE IMMEDIATELY!** Some people, including pregnant women; persons with heart or lung disease, asthma, or anemia; those under the influence of alcohol; and persons at high altitudes, are more affected by carbon monoxide than others. **(The appliance must be serviced by a qualified professional service technician before use).**

- B. If any soot appears on the appliance or other areas of the fireplace in which this appliance is installed, shut system off and call a qualified professional service technician, **vent-free gas burner system technician**, or your local gas company.
- C. This appliance may be installed in an aftermarket, permanently located, manufactured (mobile) home where not prohibited by local codes. Installation of appliances designed for manufactured homes or mobile homes must conform with the *Manufactured Home Construction and Safety Standard, Title 24 CFR, Part 3280* in the U.S.; or with *CAN/CSA Z240 MH, Mobile Housing* in Canada; or with *ANSI/NCSBCS A225.1/NFPA 501A, Manufactured Home Installations Standard* when none of the previously referenced standard are applicable.
- D. Eliminate drafts **before** using the gas appliance by closing heating and air conditioning vents, returns, and outside air vents. Fans blowing directly into the fireplace must be turned off when this appliance is operating.
- E. **WARNING:** This appliance is for installation only in a solid-fuel-burning masonry or UL 127 factory-built fireplace or in a listed ventless firebox enclosure. This appliance has been design certified for these installations. Exception: **DO NOT** install this appliance in a factory-built fireplace that includes instructions stating it has not been tested or should not be used with unvented gas burner systems.
- F. **WARNING: DO NOT MODIFY THIS VENT-FREE HEATER OR ITS CONTROLS. Any change may be dangerous.** Improper installation or use of your vent-free gas appliance can cause serious injury or death from fire, burns, explosions, or carbon monoxide poisoning.
- G. State and local codes may only allow operation of this appliance in a vented configuration. Check your state or local codes.
- H. **WHEN INSTALLING AS A DECORATIVE VENTED APPLIANCE, THE UNIT MUST CONFORM TO ALL LOCAL CODES AND TO THE LATEST EDITION OF THE NATIONAL FUEL GAS CODE ANSI Z223.1/NFPA54.**

Important: For safe operation and proper performance of this product and to comply with certification, listings, and building code acceptances, use ONLY Peterson Real Fyre controls, parts, and accessories that have been specifically listed or certified for use with this burner system. Use of other controls, parts, or accessories is prohibited and will void all warranties, certifications, listings, and building code approvals, and may cause property damage, personal injury, and loss of life.

VENTILATION AND CONFINED SPACE SAFETY INFORMATION

Your vent-free gas burner system **SHALL NOT BE INSTALLED IN A CONFINED SPACE** or unusually tight construction unless provisions are made for adequate combustion and ventilation air.

- The National Fuel Gas Code, ANSI Z223.1/NFPA 54 defines a confined space as a space whose volume is less than 50 cu. ft. per 1,000 BTU per hour (4.8 meters³ per kw) of the aggregate input rating of all appliances installed in that space.
- An unconfined space is a space where volume is at least 50 cu. ft. per 1,000 BTU per hour (4.8 meters³ per kw) of the aggregate input rating of all appliances installed in that space.
- Rooms communicating directly with the space in which the appliances are installed, through openings not furnished with doors, are considered a part of the unconfined space.

WARNING: Do not install the unvented burner system where the room is considered a confined space (see Fig. 5-1).

To determine if the area where this burner system is to be installed fits the definition of an unconfined space, multiply the length of the room by the width of the room by the height of the room, then multiply by 20. The result is the maximum BTU allowed.

(Length x Width x Height x 20 = Maximum BTUs allowed)

Example: To install a vent-free gas burner system with 36,000 BTU, maximum, in a space with no other gas-burning appliances, the space **MUST** be 1,800 cu. ft. or larger.

Assuming an 8' ceiling, floor dimensions must be a minimum of 225 sq. ft.,

i.e.; 18'x12.5'=225 sq ft (see Fig. 5-1).

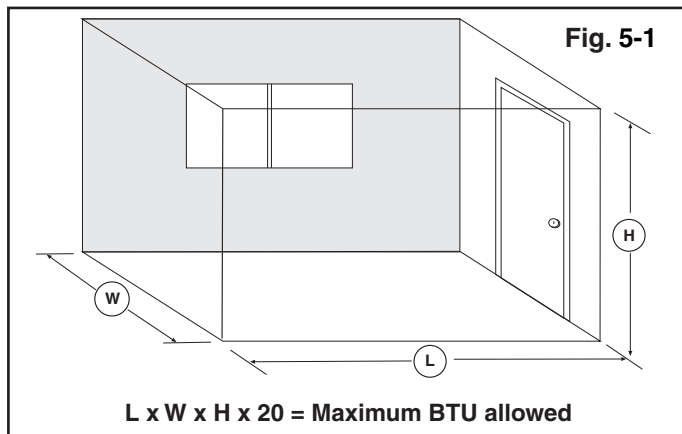

WARNING

If the area in which the heater may be operated is smaller than that defined as an unconfined space or if the building is of unusually tight construction, provide adequate combustion and ventilation air by one of the methods described in the National Fuel Gas Code, ANSI Z223.1/NFPA 54, Air for Combustion and Ventilation, or applicable local codes.

REMEMBER

$L \times W \times H \times 20 = \text{MAXIMUM BTUs ALLOWED}$

If the space is smaller than the above formula allows, and/or smaller than the examples and diagrams on this page specify, **DO NOT** install the vent-free burner system unless provisions for additional combustion and ventilation air are made.

IT MAY BE NECESSARY TO OPEN A WINDOW SLIGHTLY (1" - 2") OR OTHERWISE INCREASE VENTILATION. CONDITIONS REQUIRING THIS INCLUDE, BUT ARE NOT LIMITED TO:

1. Installation in a **CONFINED SPACE**.
2. Installation in a **HOME OF UNUSUALLY TIGHT CONSTRUCTION****.
3. Installation at **HIGH ALTITUDES**.
4. **Certain MEDICAL OR PHYSICAL CONDITIONS OF THE HOMEOWNER** that may be adversely impacted by combustion products created by burning natural or propane gas.

Installation in a tightly constructed home and/or installation at high altitudes may cause your vent-free burner system to produce excessive heat or excessive moisture. The oxygen depletion sensor may shut down the burner system. These conditions may be corrected by opening a window or otherwise increasing the number of air changes in the home.

**Unusually tight construction is defined as construction where:

- a. Walls and ceilings exposed to the outside atmosphere have a continuous water vapor retarder with a rating of 1 perm (6×10^{-11} kg per pa-sec- m^2), or less with openings gasketed or sealed;
- b. Weather stripping has been added on openable windows and doors, and
- c. Caulking or sealants are applied to areas such as joints around window and door frames, between sole plates and floors, between wall-ceiling joints, between wall panels, at penetrations for plumbing, electrical, and gas lines, and at other openings.

This vent-free burner system has been certified to function safely and reliably with emission by-products well within accepted safety and health standards. **Your specific medical or physical condition** may render you more sensitive to products created by burning natural or propane gas. If this is the case, you should open a window or otherwise increase ventilation.

MINIMUM CLEARANCES TO COMBUSTIBLES

If the vent-free burner system is installed in a factory built fireplace, follow the manufacturer's guidelines for minimum clearances to combustibles.

In the absence of such guidelines, follow the instructions below:

Clearances to Combustible Construction:

Sidewalls: 6" from side of fireplace opening (Fig. 6-1).

Ceiling: 42" from top of fireplace opening (Fig. 6-1).

Flooring: See IN FRONT OF FIREPLACE section below.

Mantel: See ABOVE THE FIREPLACE section below & Fig. 6-1. Also see Fig. x-1, & x-2 on following page).

Note: Clearances to combustible construction are those distances required to ensure that fireplace mantels, facings, walls, ceilings, and floorings will not catch fire.

In most cases, these clearances should also be adequate to prevent any discoloration or warping due to heat. However, every gas burner installation presents a different and unique set of circumstances involving many variables beyond the control of the manufacturer. These include paint or finish composition, previous exposure to heat, methods and quality of construction, air flow patterns, glass doors, fans or blowers, etc.

IN FRONT OF THE FIREPLACE:

Be certain that combustible flooring material (i.e.: carpet, tile, etc.) is not too close to the vent-free unit. If the vent-free burner system is at floor level or less than 6" above the floor, there **MUST** be at least 12" (1 foot) of noncombustible material between the front of the fireplace and any combustible flooring.

ABOVE THE FIREPLACE:

To install the vent-free burner system, there must **ALWAYS** be noncombustible or heat resistant material immediately above the fireplace opening. Heat resistant materials (i.e., marble or slate) must be at least $\frac{5}{8}$ " thick. Sheet metal should not be installed onto combustible materials.

If you **DO NOT** install a fireplace hood, there **MUST** be at least 12" of noncombustible or heat resistant material immediately above the fireplace opening (**see A** in Fig. x-1 on the following page). If you **DO** install a fireplace hood, there **MUST** be at least 10" of noncombustible or heat resistant material immediately above the fireplace opening (**see B** in Fig. x-2 on the following page). If there is a wooden mantel, shelf, or other combustible projection above the fireplace, follow the information in the Figures on the next page.

EXAMPLE: If the fireplace has a combustible projection (mantel or shelf) 20" above the top of the firebox, the maximum horizontal projection out from the face of the fireplace will be:

1. If a fireplace hood is not installed - **2.5"** (see Fig. x-1 on the following page).
2. If a fireplace hood is installed ----- **10"** (see Fig. x-2 on the following page).

A fireplace hood deflects heat away from the fireplace face and mantel, reducing the potential for heat related warping or discoloration. The use of a fireplace hood is highly recommended.

DO NOT place any combustible decorations/items on the mantel or above the fireplace.

IF YOU CANNOT MEET THESE MINIMUM CLEARANCES, YOU MUST OPERATE THE VENT-FREE BURNER SYSTEM WITH THE CHIMNEY FLUE DAMPER OPEN.

Note: Fig. x-1 & x-2 on the following page are for standard G8 burners.
Refer to Fig. x-3 & x-4 for G8 9,500 BTU burners.

Because of these variables, we cannot guarantee that heat warping or discoloration will never occur. The potential for heat warping or discoloration may exist no matter what item(s) you are burning in the fireplace, including wood.

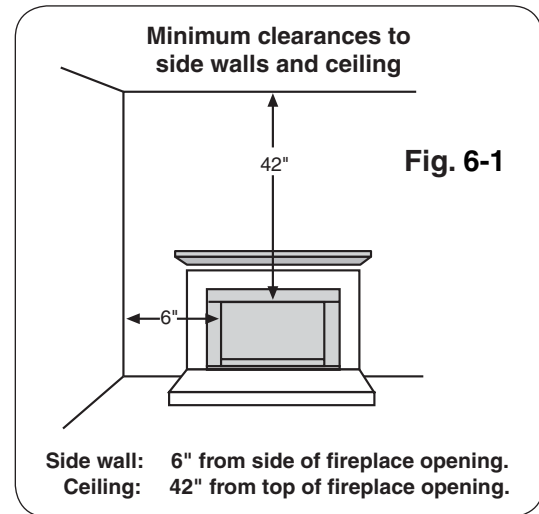

The dimensions in Fig. 6-1 are **MINIMUM CLEARANCES** to maintain when you install this burner system. **BOTH SIDES** of the fireplace opening **MUST BE AT LEAST 6"** from any combustible sidewalls. The ceiling **MUST BE** at least **42"** from the top of the fireplace opening.

MINIMUM CLEARANCES TO COMBUSTIBLES (Cont.)

IF YOU CANNOT MEET THESE MINIMUM CLEARANCES, YOU MUST OPERATE THE VENT-FREE GAS BURNER SYSTEM WITH THE CHIMNEY FLUE DAMPER OPEN.

MANTEL CLEARANCES FOR G8E STANDARD BURNERS ONLY

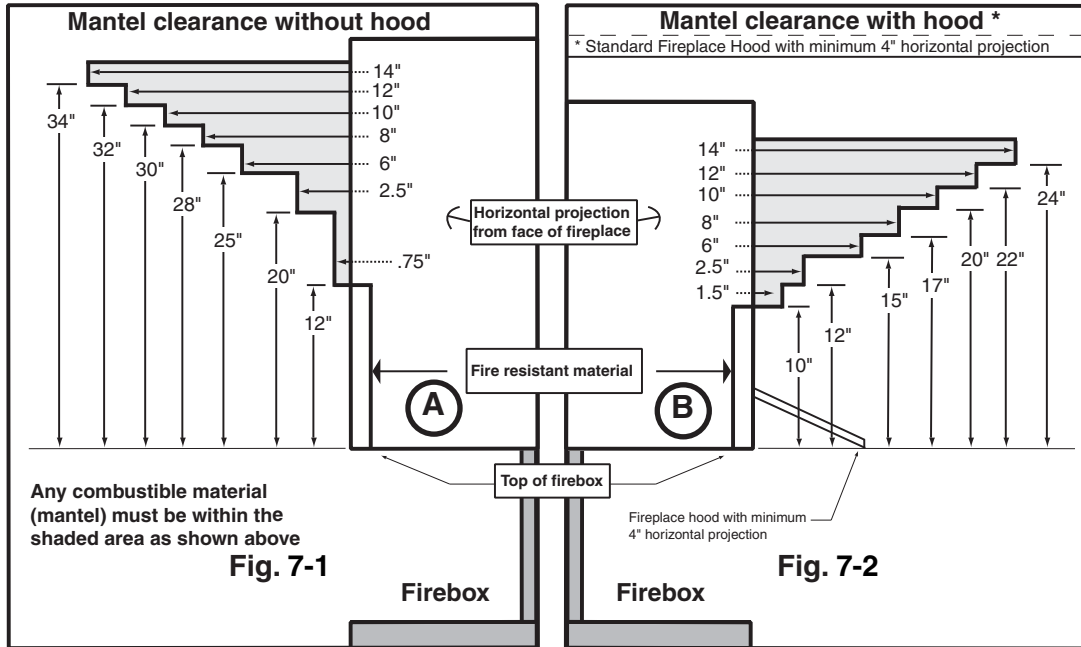

MANTEL CLEARANCES FOR G8E 9,500 BTU BURNERS ONLY

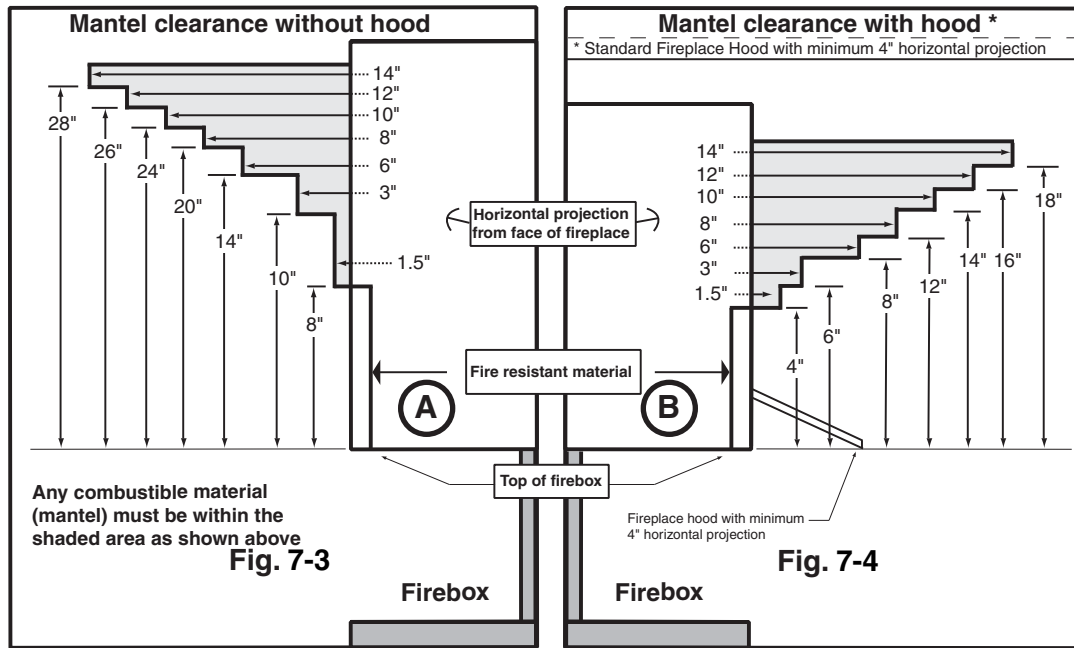

PRE-INSTALLATION AND FIREPLACE PREPARATION SAFETY

CAUTION: Installation and repair must be done by an NFI certified or other qualified professional installer.

Installer: Carefully read these instructions before installing this gas burner system. Be sure you understand all safety precautions and warnings contained in this manual.

PRE-INSTALLATION AND FIREPLACE PREPARATION SAFETY GUIDELINES

A. CAUTION: If not installed, serviced, and used correctly per these instructions, this product can cause serious personal injury, property damage, or loss of life.

B. WARNING: When installing in a solid-fuel-burning fireplace, the chimney flue, damper, and firebox must be thoroughly CLEANED of soot, creosote, ashes, and loose paint by a qualified chimney cleaner. Some fireplaces (especially older ones) may need repair prior to installing this appliance.

C. This appliance is only for use with the type of gas indicated on the rating plate. This appliance is **NOT CONVERTIBLE** for use with other gasses.

CHECK GAS TYPE (natural or L.P): The gas supply must be the same as stated on your burner system rating plate. If gas supply is different, **DO NOT INSTALL**. Contact your dealer for immediate assistance.

D. Any outside air ducts and/or ash dumps located on the floor or walls of the fireplace must be permanently sealed shut before the installation. Use a heat-resistant sealant. Do not seal the chimney flue damper.

E. INSUFFICIENT GAS PRESSURE WILL KEEP THE ODS (OXYGEN DEPLETION SENSOR) PILOT FROM OPERATING PROPERLY. DO NOT USE IF GAS PRESSURE IS LOWER THAN THE MINIMUM REQUIREMENT.

F. The *minimum* inlet gas-supply pressure for purposes of input adjustment is **5"** water column (w.c.) on **natural gas** and **11"** w.c. on **L.P. gas**. Insufficient gas pressure will affect proper operation of the ODS pilot. Do not install this gas appliance if minimum pressure is not available. The *maximum* inlet gas-supply pressure is **10.5"** w.c. on natural gas and **13"** w.c. on L.P. gas. The L.P. source must be regulated. **(Do not connect this appliance directly to an unregulated L.P. gas tank - this can cause an explosion.) Do not connect this appliance to a portable L.P. gas cylinder.**

G. **The gas piping system must be sized to provide minimum inlet pressure at the maximum flow rate (BTU/hr).** Undue pressure loss will occur if the pipe is too small, or the run is too long. Gas supply pipe must be 1/2" minimum interior diameter. If the gas line is longer than 20', a larger diameter line may be necessary. Refer to the NFPA 54 guidelines for further details.

H. The minimum clearance from the fireplace opening to combustible materials on side walls and ceiling must be maintained as outlined in MINIMUM CLEARANCE TO COMBUSTIBLES - WALLS AND CEILING.

I. At least 10"-12" of noncombustible or heat-resistant material is required above the fireplace. A fireplace hood will be required to act as a heat deflector in protecting combustible fireplace surrounds (facing and/or mantel) if certain minimum clearances cannot be met.

J. Be certain that combustible flooring material (i.e., carpet, tile, etc.) is not too close to this gas appliance. If this appliance is at floor level or less than 6" above the floor, there must be at least 12" of noncombustible material between the base of the fireplace and any combustible flooring.

K. Input ratings shown in BTU per hour are for elevations up to 2,000 ft. For elevations above 2,000 ft., refer to the National Fuel Gas Code or contact the Robert H. Peterson Company before installing this product.

L. This gas appliance and its main gas valve must be disconnected from the gas-supply piping system during any pressure testing of that system at test pressures in excess of 1/2 psig.

M. This gas appliance must be isolated from the gas-supply piping system by closing the equipment shutoff valve connected to the gas-supply line during any pressure testing of the gas-supply piping system at test pressures equal to or less than 1/2 psig.

N. Do not use this appliance if any part has been underwater. Immediately call a qualified professional service technician to inspect the appliance and to replace any part of the control system and any gas control that has been underwater.

WARNING

THIS APPLIANCE IS EQUIPPED FOR EITHER NATURAL OR PROPANE GAS.
FIELD CONVERSION IS NOT PERMITTED.

INSTALLATION SAFETY INFORMATION

INSTALLATION SAFETY GUIDELINES

- A. Carefully inspect the burner and log cartons for shipping damage. If any parts are missing/damaged, call your dealer. **Do not attempt** to install the appliance unless all parts are in good condition.
- B. Correct installation of the glass or the ceramic refractory log set and proper placement and installation of the burner assembly, including ember placement and Lava Granule placement, are imperative to safe operation of your set. Problems **WILL** occur if all items are not properly installed. Reference the INSTALLATION section, LOG SET PLACEMENT.
- C. When installing in a wood-burning fireplace, **center the appliance in the fireplace** while making certain that no part of the assembly protrudes (forward) beyond the face of the fireplace.
DO NOT PUSH THE UNIT ALL THE WAY TO THE BACK.
- D. If you use Lava Granules, or glass or gems, for decorative use, do not allow these accessories into or onto any part of the burner or on the logs. Lava Granules, or glass or gems used to accessorize the vent-free burner, should only be placed on the floor of the fireplace, in front of and to the sides of the burner, but away from the controls.
- E. **DO NOT PLACE** logs or other accessories, such as wood chips, pine cones, or vermiculite, on this appliance. These items will cause improper burning, sooting, and/or high levels of carbon monoxide. Additional logs and/or accessories may be placed around the burner system, as long as they do not interfere with the burning of your gas appliance.
- F. **Due to high temperatures, this appliance should be located out of traffic and away from furniture/ draperies.**
- G. A fireplace screen must be in place when this gas appliance is in operation. Unless other provisions for combustion air are provided, the screen shall have an opening(s) for introduction of combustion air.
- H. Connecting directly to an unregulated L.P. tank can cause an explosion.
- I. Special care is required if you are installing the unit into a **SUNKEN FIREPLACE**. You must raise the fireplace floor to allow access to gas controls. This will ensure adequate airflow and guard against sooting. Raise the fireplace floor using noncombustible materials.
- J. A vent-free room heater having an input rating of more than 10,000 BTU per hour shall not be installed in a bedroom (ANSI Z21.11.2).
If local codes allow, you may install a G8E-xxR burner, having a rating of 9,500 BTU, in a bedroom. An unvented room heater having an input rating of more than 6,000 BTU per hour shall not be installed in a bathroom (ANSI Z21.11.2).

Fireplace Floor Requirement

DO NOT install this burner system if the fireplace hearth is recessed. The fireplace floor must be at the same level as or higher than the fireplace front opening. An ash lip or recess may not exceed $\frac{3}{4}$ ". See Fig. 9-1 below.

Note: If glass doors are used: the fireplace floor must not be blocked by the door frame.

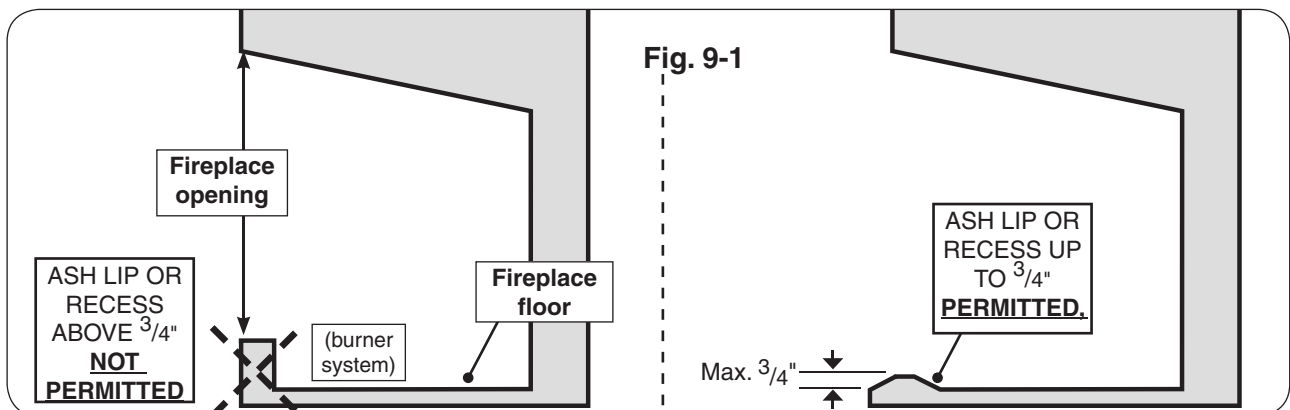

OPERATIONAL SAFETY INFORMATION

OPERATING YOUR UNVENTED GAS APPLIANCE SAFELY AND CORRECTLY

- A. SOLID FUEL MUST NOT BE BURNED** in a fireplace where this vent-free gas appliance is installed.
- B. GLASS DOORS MUST BE FULLY OPEN** when this vent-free gas appliance is operating. This appliance **MUST NOT BE ON** if glass doors are closed, as it can lead to sooting, burner outages, and possibly explosion, causing damage or injury.
- C. WARNING: DO NOT ALLOW DRAFTS INTO OR AROUND THE FIREPLACE. CLOSE (SHUT) HEATING AND AIR CONDITIONING VENTS, RETURNS, AND OUTSIDE AIR VENTS. DO NOT OPERATE FANS (WINDOW FANS, CEILING FANS, FLOOR FANS), WHICH MAY ALTER FLAME PATTERNS.** Sooting, excess carbon monoxide, or ODS pilot outages may occur due to drafts.
- D. WARNING: DO NOT USE A BLOWER INSERT, HEAT EXCHANGER INSERT,** or any other accessory that is not specifically certified for use with this vent-free gas appliance.
- E.** Make sure there is adequate combustion and ventilation air when this gas appliance is operating. You may need to crack the damper or open a window slightly.
- F. THIS APPLIANCE MUST BE MAINTAINED IN A WELL-CLEANED CONDITION AT ALL TIMES. REGULAR (AT LEAST ONCE PER YEAR) CLEANING OF THE BURNER AND ODS PILOT IS REQUIRED BY A QUALIFIED PROFESSIONAL SERVICE TECHNICIAN.**
- G.** To light this appliance, it may be necessary to purge the unit for longer than one minute after long periods of non-use.
- H.** If you operate this vent-free gas appliance fueled by L.P., operating characteristics may vary as the fuel in the tank approaches empty (**less than 1/4 full**). Sooting and other increases in combustion by-products will occur. Turn off the appliance, refill the L.P. tank, and have the burners cleaned.
- I.** During manufacturing, various parts of this unit are treated with oils or paints. Though not harmful, they may **produce annoying smoke and smells** as they are burned off during initial operation. This is a normal occurrence. Initial break-in period should **last four to six hours**; maximum ventilation should be provided by opening windows, doors, or chimney flue.
- J.** Keep the area around your gas appliance clear of combustible materials, gasoline, and any other flammable vapors/liquids. Provide adequate clearance for servicing and operation. Be especially cautious if this gas appliance is installed in a basement or converted garage.
- K.** Do not place clothing or any flammable material on or near your vent-free gas appliance. Matches, paper, garbage, or any other material must not be thrown on top of the logs, burner, or into the flame.
- L. Young children should be carefully supervised when in the same room with this appliance.**
- M.** Children and adults should be alerted to the hazard of high surface temperatures and should stay away to avoid burns or clothing ignition.

OPERATIONAL SAFETY INFORMATION (Cont.)

OPERATING YOUR UNVENTED GAS APPLIANCE SAFELY AND CORRECTLY

- N. **This appliance is intended for supplemental heating, and is not a primary heating source.** Water vapor produced by vent-free burner systems can create moisture problems in a home when operated for extended periods of time. If condensation begins to occur, open your damper or a window.
- O. If the gas quality is poor or pressure low, your ODS pilot may not stay lit, the burners may produce soot, or the unit may backfire. Contact your local gas supplier immediately.
- P. This appliance is designed for adults to be present while in operation. Do not leave this unit burning when unattended or while sleeping. **This is an attended appliance.**
- Q. **WARNING:** Failure to keep the primary air opening(s) of the burner(s) clean may result in sooting and property damage.
- R. **WARNING: All previously applied loose material, such as embers, must be removed prior to reapplication. All replacement loose material must be purchased from the original appliance manufacturer.**
- S. Unusually tight construction is defined as:
 - a. Walls and ceilings exposed to the outside atmosphere have a continuous water vapor retarder with a rating of 1 perm (6×10^{11} kg per pa-sec- m^2) or less with openings that are sealed or use gaskets;
 - b. Weather stripping has been added on openable windows and doors; AND
 - c. Caulking or sealants are applied to areas such as joints around window and door frames; between sole plates and floors; between wall-ceiling joints; between wall panels; at penetrations for plumbing, electrical, and gas lines; and at other openings.
- T. Burning candles, air fresheners and sprays will cause objectionable odors to be created by the unvented burner system.

CLEANING AND SERVICING IMPORTANT INFORMATION

It is imperative that you maintain your unvented gas appliance by having it cleaned and serviced regularly. A qualified professional service technician shall inspect and service this unit at least annually. (Read and follow the CLEANING AND SERVICING sections for details.)

Failure to provide reasonable and necessary maintenance as outlined in the owner's manual will cause your appliance to malfunction and will void your warranty.

G8E BURNER PARTS LIST - MANUAL SERIES

Note: Photos not to scale

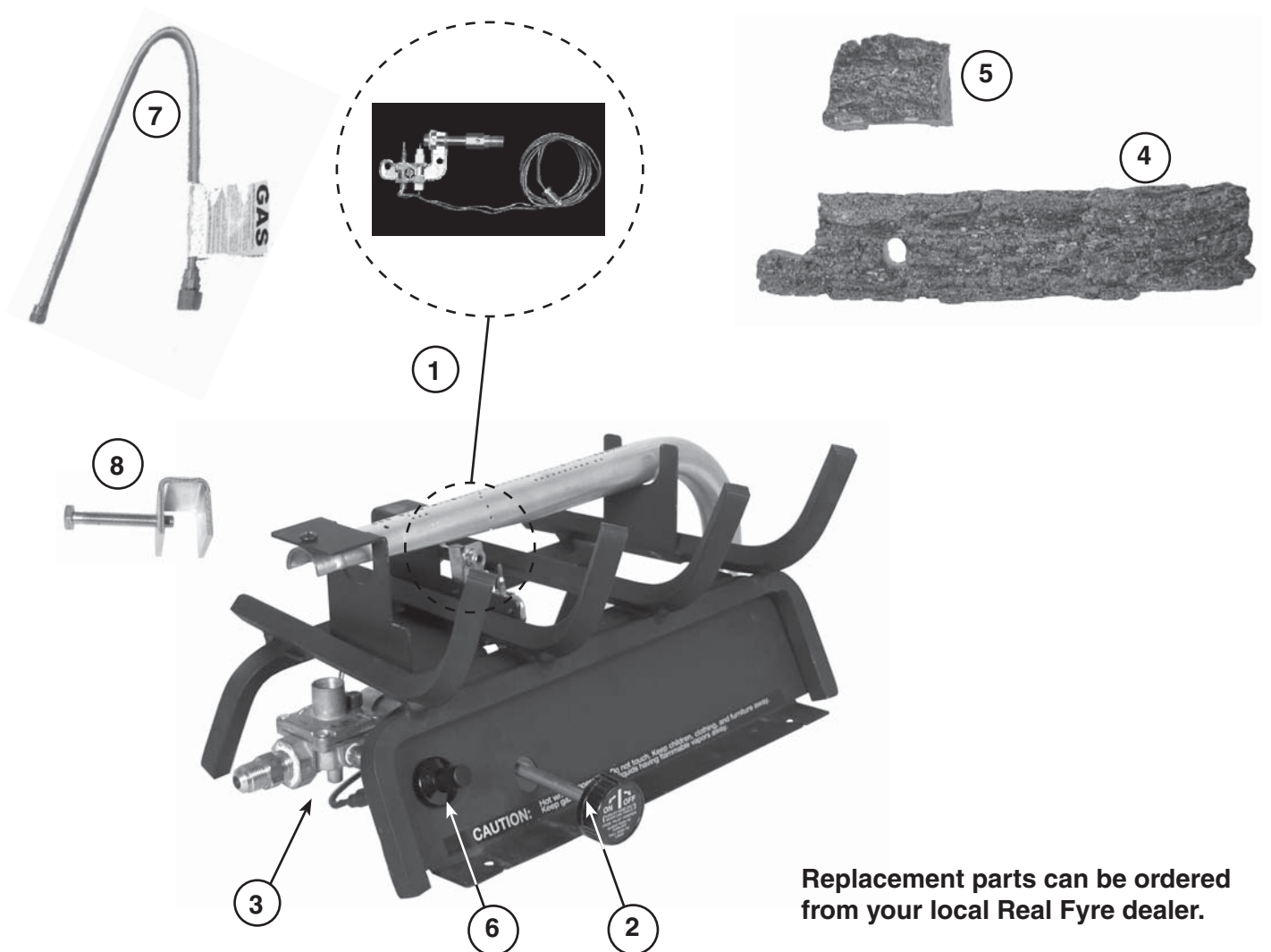

Replacement parts can be ordered from your local Real Fyre dealer.

The log set is purchased and packaged separately; contact your local dealer when ordering. Refer to the instructions included with the log set.

Item	Description	Part No.	Qty.
1.	ODS pilot assembly (natural)	ODS-0001	1
or	ODS pilot assembly (propane)	ODS-0002	1
2.	Control valve	SV-18	1
3.	Pressure regulator (natural)	PR-2NAT	1
or	Pressure regulator (propane)	PR-1LP	1
4.	Decor panel	DC-8E	1
5.	Wood chip	WC-10-1	1
6.	Piezo igniter	PZ-1	1
7.	Flex connector (w/ adapter), 3/8" O.D. X 30"	CK-12	1
8.	Damper clamp	DC-1	1

G8E BURNER PARTS LIST - 12 SERIES

Replacement parts can be ordered from your local Real Fyre dealer.

Note: Photos not to scale

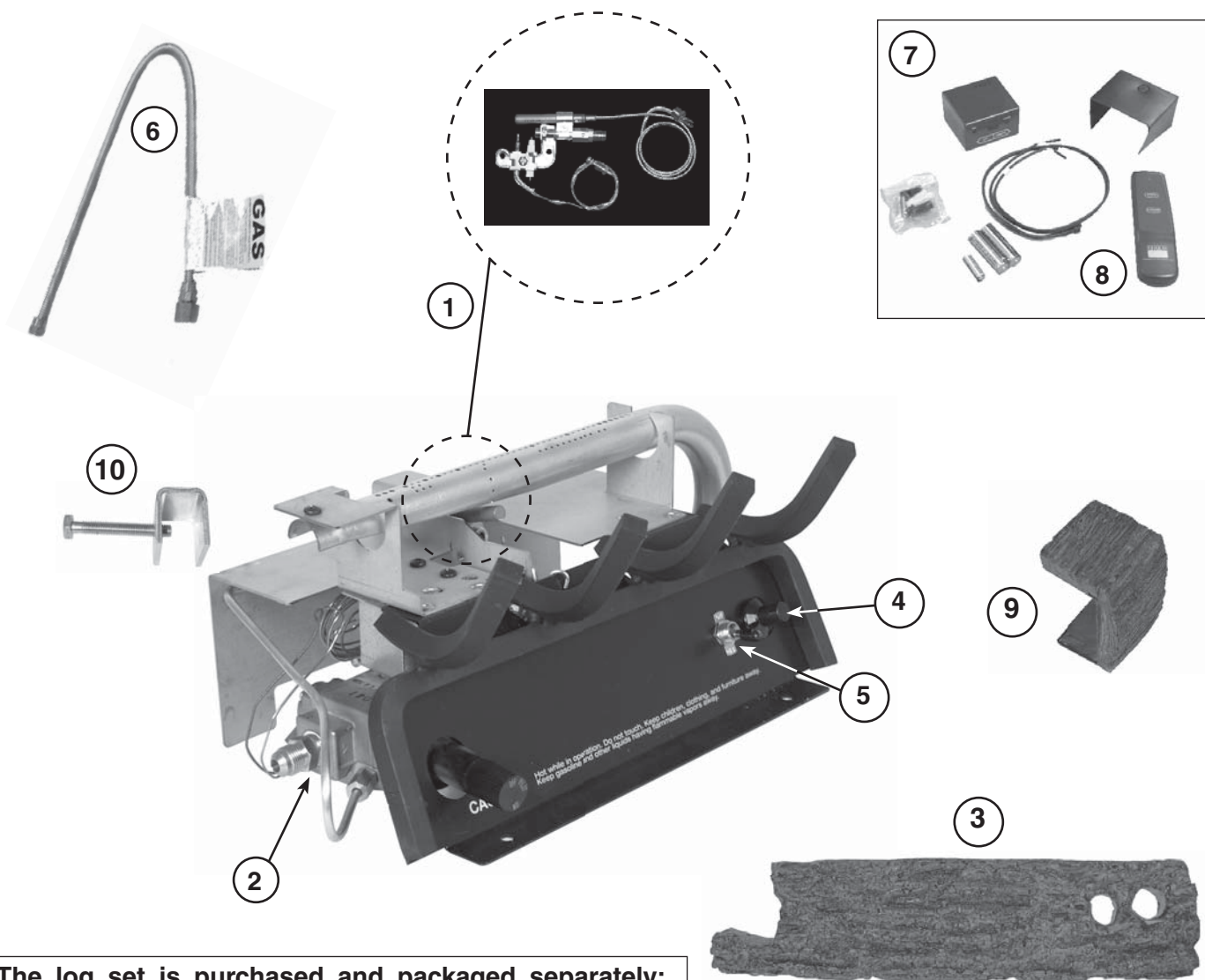

The log set is purchased and packaged separately; contact your local dealer when ordering. Refer to the instructions included with the log set.

Item	Description	Part No.	Qty.
1.	ODS pilot assembly (natural)	ODS-0003	1
or	ODS pilot assembly (propane)	ODS-0004	1
2.	Control valve (natural)	SV-8	1
or	Control valve (propane)	SV-8P	1
3.	Decor panel	DC-8E-R	1
4.	Piezo igniter	PZ-1	1
5.	Toggle switch	SW-2	1
6.	Flex connector (w/ adapter), 3/8" O.D. X 30"	CK-12	1
7.	Remote kit * (includes receiver, transmitter, batteries, plastic cover)	RR-1A	1
8.	Remote transmitter (only) *	AT-R1-1	1
9.	Decorative heat shield *	HS-36	1
10.	Damper clamp	DC-1	1

* If equipped

WHEN USED AS A VENTED DECORATIVE APPLIANCE (PER ANSI Z21.60)

This appliance is for installation in a solid-fuel-burning fireplace (masonry fireplace or manufactured fireplace) with a working flue and constructed of noncombustible material.

This burner system may be installed as vented decorative appliance in compliance with ANSI Z21.60 and National Fuel Gas Code, Section 6.6. The minimum permanent free opening of the fireplace chimney or chimney damper must be met per the Chimney Vent Opening Table on pg 3 of this manual. Chimney damper must be fixed in a manner to maintain permanent free opening at all times. To accomplish this, install a screw or bolt in the edge of the damper to prevent closing, or drill holes in the damper or remove the damper.

DAMPER CLAMP INSTRUCTIONS (WHEN USE AS A VENTED DECORATIVE APPLIANCE)

If the burner system is installed as a vented decorative appliance:

The damper clamp with hex bolt (Fig. 14-1) is provided as a means to prevent full closure of the damper blade. The clamp is easily attached to most damper blades with pliers or a wrench, and must be permanently installed. The clamp is designed to prevent accidental closure of the damper when installed as illustrated (Fig. 14-2 and Fig. 14-3). Should the clamp not fit, or fail to provide the permanent vent opening specified in Table 3-1, have a permanent stop installed, remove the damper blade, or have the damper cut to provide the minimum permanent opening required.

The damper clamp is not required if the burner system is installed as an unvented room heater.



Fig. 14-1

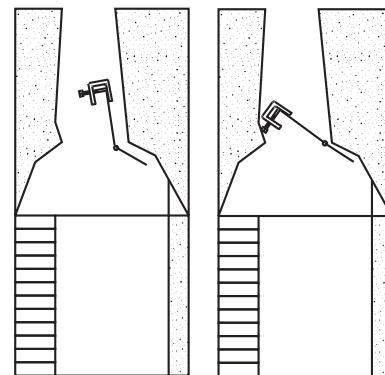

Open
Fig. 14-2

Closed
Fig. 14-3

INSTALLATION

BEFORE PROCEEDING, CAREFULLY READ ALL OF THE IMPORTANT SAFETY INFORMATION CONTAINED IN THIS OWNER'S MANUAL, INCLUDING:

- A. Pre-Installation and Fireplace Preparation Safety Guidelines
- B. Ventilation and Confined Space Information
- C. Installation Safety Guidelines

I M P O R T A N T

Be sure you have read and understand all safety precautions and warnings contained in this manual.

Note: To install the unvented gas burner system, the fireplace must have a gas-supply line that has been installed by a qualified professional service technician in accordance with all local codes. Refer to the PARTS LIST when installing the burner system.

Tools Required:

1. Adjustable open-ended wrench
2. Pliers
3. Propane gas-resistant pipe compound or Teflon tape
4. Soapy water solution and brush for leak detection
5. Standard screwdriver
6. Manometer (for checking gas pressure)

CHECK GAS TYPE (natural or propane). The gas supply must be the same as stated on the burner system rating plate. **If the gas supply is different, DO NOT INSTALL.** Contact the dealer for immediate assistance.

W A R N I N G

Do not connect this appliance directly to a high-pressure natural gas line or an unregulated propane tank.

WARNING: Failure to position these parts in accordance with these diagrams or failure to use only parts specifically approved with this unvented burner system may result in property damage or personal injury.

INSTALLATION (cont.)

The Real Fyre burner system must be installed by a qualified professional service technician. Instructions must be followed carefully to ensure proper performance and full benefit from the burner system. **Fireplace floor must be level, clean, and smooth.**

REFER TO THE PARTS LIST WHEN FOLLOWING THESE INSTRUCTIONS.

16/20/24" burner model shown here.

INSTALL BURNER

1. MAKE SURE THE FIREPLACE GAS SUPPLY IS TURNED OFF.
2. Locate the gas-supply stub inside the fireplace and remove the cap, if attached (reference Fig. 15-1).

CAUTION: When removing the cap, make sure the stub does not turn, loosening the connection inside the wall.

3. Place the burner system in the fireplace. Center the burner in the fireplace. (Reference Fig. 15-2 for orientation.)
4. **Be sure gas to the fireplace is off.** Remove the adapter connected to the flex connector (pre-installed on the burner system). Attach the adapter to the gas-supply stub using a pipe compound resistant to all gasses. Tighten securely. Then attach the open end of the flex connector to the adapter. Tighten securely. (See Fig. 15-1.)
5. **LEAK TEST:** Turn on the fireplace gas supply, and test at all connections for leaks using the appropriate soapy water solution. If bubbles appear, a leak is present. Turn off the gas and tighten at all connections. Repeat until no leaks are present. If a leak persists, turn off the gas supply and contact the local gas company or dealer. **NEVER USE A FLAME TO CHECK FOR LEAKS.**

INSTALL REMOTE - 12 MODELS ONLY (if equipped)

1. At this stage the remote system batteries are to be installed. Reference the INSTALL/REPLACE BATTERIES section for details.
2. Locate the toggle switch on the right front of the burner. Remove and discard the two extra connectors on the terminals. See Fig 15-3, A.

Note: Do not disconnect the pre-installed valve wires from the toggle switch - only the extra connectors.

3. Locate the wires coming off of the remote receiver, and connect them to the two now exposed terminals on the toggle switch / valve wires (see Fig. 15-3, B).
4. **Place the remote receiver at the front right corner of the fireplace. Place as far from the burner system as possible.** See Fig. 15-4.
5. Place the plastic cover over the remote receiver with the open side facing forward to allow access to the receiver controls. Then place the decorative heat shield. See Fig. 15-4.

CAUTION: THE REMOTE RECEIVER WILL BE HOT DURING AND AFTER OPERATION.

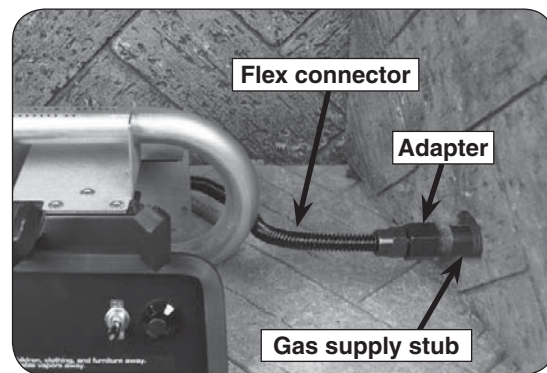

Fig. 15-1 Connect gas supply

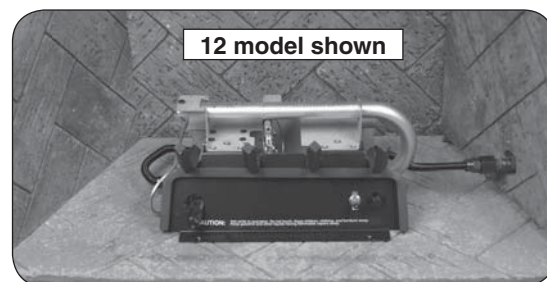

Fig. 15-2 Overall orientation

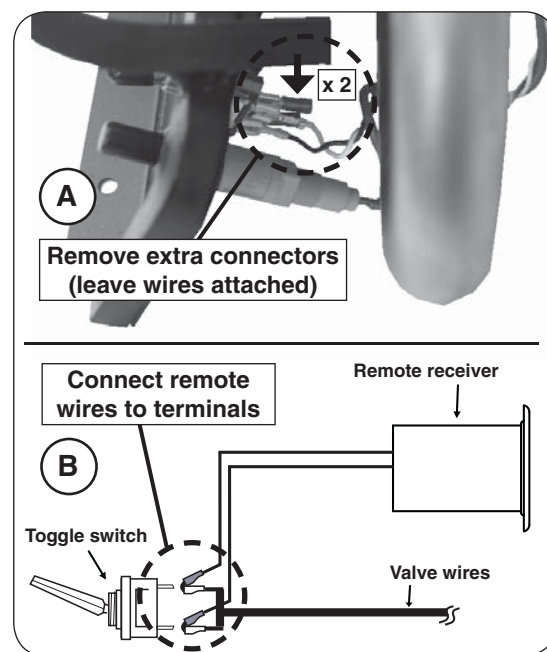

Fig. 15-3 Connect remote receiver

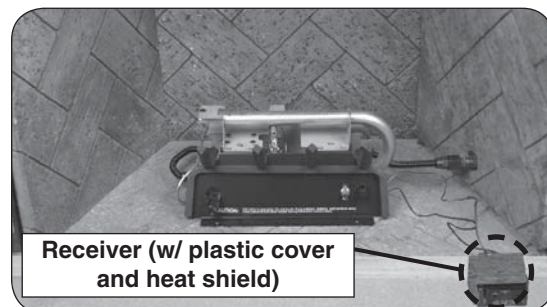

Fig. 15-4 Place remote receiver

CONTROL SETTINGS

It is recommended that before you install the decorative media, you familiarize yourself with the control valve layout. This will assist you when operating the burner system. See Fig. 16-1 through 16-2 for the control positions of your specific model.

LIGHTING TEST

Prior to proceeding with installation, perform a lighting test (see lighting instructions for lighting your burner). **Allow the unit to completely cool after testing.**

IMPORTANT

For all valves, the air **MUST** be purged from the gas line before the pilot will light and burn properly. The time needed to purge will depend on the length of the gas line to the unit and the amount of time since the unit or gas line was last used. It may take several minutes before all the air is purged and the pilot will light and burn properly. Reference the LIGHTING INSTRUCTIONS section in this manual.

GAS PRESSURE

At this stage, the gas pressure is to be checked. Reference the CHECK GAS PRESSURE section for details.

SECURE BURNER TO FLOOR

Two anchoring holes are provided on the base of the burner assembly for securing it to the fireplace floor in a mobile home, or if the installation or inspector require it in other circumstances. Using the appropriate hardware for your fireplace construction (not included), secure the burner system into the fireplace floor (see Fig. 16-3).

Note: If you have a manufactured fireplace, check with the manufacturer before drilling holes in the floor.

INSTALL DECOR PANEL

Install the decor panel onto the front of the burner (see Fig. 16-4 for 12 valve models and Fig. 16-5 for manual models).

Note: For manual models only the valve control knob must be removed in order to place the decor panel. Then replace the knob and place the supplied wood chip in front of the knob (see Fig. 16-5).

CAUTION: THE DECOR PANEL AND WOOD CHIP (IF APPLICABLE) WILL BE HOT DURING AND AFTER OPERATION.

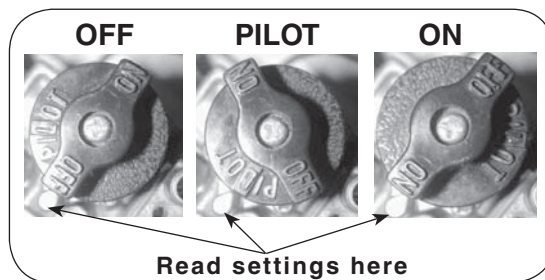

Fig. 16-1 12 valve operating positions



Fig. 16-2 Manual valve operating positions

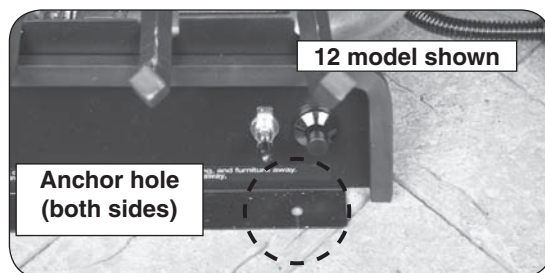

Fig. 16-3 Secure burner to floor (if required)

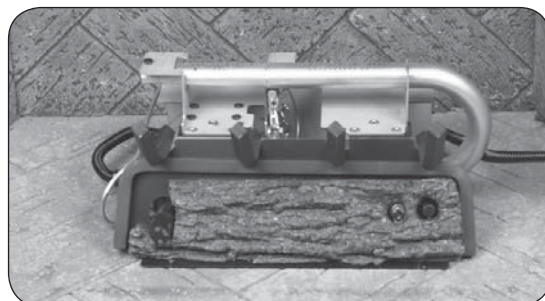

Fig. 16-4 Decor cover installed (12 valve)

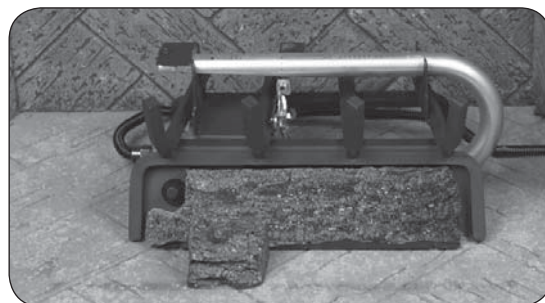

Fig. 16-5 Decor cover installed (manual valve)

LAVA GRANULES (OPTIONAL)

Optional lava granules are available for decorative purposes. Contact your local dealer for ordering information. If purchased, follow the steps below.

1. Spread the supplied lava granules on the floor of the fireplace, around the front and sides of the burner system (see Fig. 17-1). The lava granules may be placed around the remote receiver (if applicable). Leave the front of the receiver clear for control access.

Note: DO NOT place any lava granules on the burner system, or behind it.

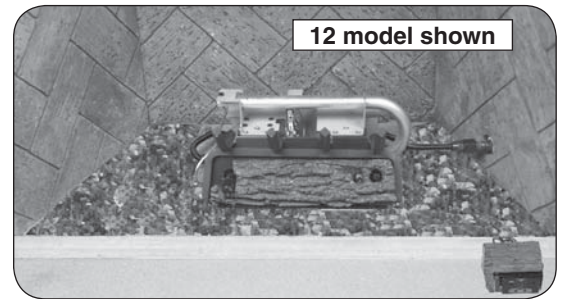

Fig. 17-1 Place lava granules

LOG SET PLACEMENT

- Follow the instructions included with the log set for step by step log placement.
- Read all safety warnings and important information in the instructions supplied with the log set to ensure proper placement.
- Periodically check the positioning of the logs to ensure proper log placement.



Valley Oak (VO8E-20) shown

FOLLOW THE INSTRUCTIONS INCLUDED WITH YOUR SPECIFIC LOG SET TO COMPLETE LOG PLACEMENT.

After setting the logs into position, ensure each is properly and firmly seated. The vent-free gas log set will not function as intended if the logs are not correctly positioned. When placed properly, the flames will not strike any portion of the logs. Periodically check the positioning of all logs to ensure proper log placement and stability. If any flame is striking the logs, recheck log placement. Adjust to conform with instructions. **There should be no flame impingement on the logs.**

Important: Adequate spacing between the logs is **NECESSARY** and **MUST** be maintained. If carbon build up (sooting) exists, correct log placement before sooting becomes worse. **If any sooting occurs outside of the firebox (i.e. on the walls), turn off unit immediately and contact a qualified professional service technician.**

CAUTION: **BURN HAZARD!** Logs will remain hot for some time after use. If you need to reposition any log to maintain the proper layout, use heat-resistant gloves or allow logs adequate time to cool before handling.

INSTALL/REPLACE BATTERIES (IF APPLICABLE)

CAUTION: Ensure the unit is connected to the gas line and has been tested for leaks before you insert batteries.

CAUTION: Turn off the remote and/or burner and allow the unit to completely cool prior to any battery replacements.

Important: Prior to inserting batteries, always apply a small amount of dielectric grease to both ends of each battery. This will ensure conductivity and prevent moisture from affecting the contact.

Important: **Low/dead batteries will affect burner system operation. Replace batteries any time the burner will not turn on.**

REMOTE TRANSMITTER BATTERY

The remote transmitter requires one 12V battery to operate (included). Locate the transmitter, remove the lid (found on rear), and properly insert the new battery as marked. Re-secure the lid. See Fig. 19-1.

REMOTE RECEIVER BATTERIES

The remote receiver requires 4 AA batteries to operate (included). Locate the remote receiver and turn it over. Slide open the lid, and properly insert the new batteries as marked. See Fig. 19-2.

Replace the lid, then re-position the remote receiver in the fireplace. (Ensure the plastic cover and decorative heat shield are properly in place over the receiver.)

Important: Be sure to replace the decorative heat shield over the receiver after battery replacement.



Fig. 19-1 Transmitter battery

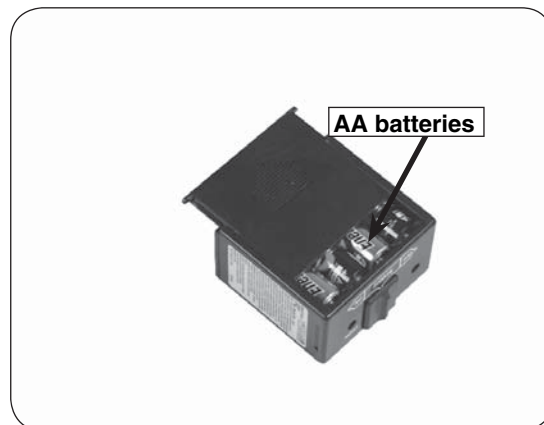

Fig. 19-2 Remote receiver batteries

CHECK GAS PRESSURE

IMPORTANT

Check the gas pressure with the system burning and the control fully **ON**.

The burner system and its main gas valve must be disconnected from the gas-supply piping system during any pressure testing of that system at test pressures in excess of 1/2 psig (3.5 kPa). The burner system must be isolated from the gas-supply piping system by closing its equipment shutoff valve during any pressure testing of the gas-supply piping system at test pressures equal to or less than 1/2 psig (3.5 kPa). This is accomplished by closing the gas-supply line valve.

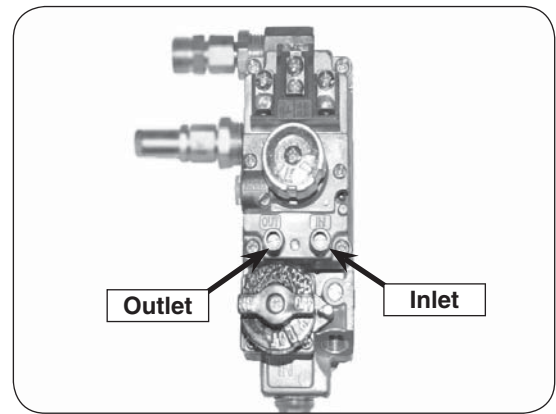

Fig. 20-1 12 valve: check pressure

12 VALVE

Check the valve regulator pressure at the pressure *inlet* point. Turn the inlet screw counterclockwise 2 or 3 turns and then place the tubing of the pressure gauge over the pressure *inlet* point. (The test “inlet” tap is marked **IN**.) After taking the pressure reading, turn the inlet screw clockwise firmly to reseal. Do not over-torque. Check for gas leaks.

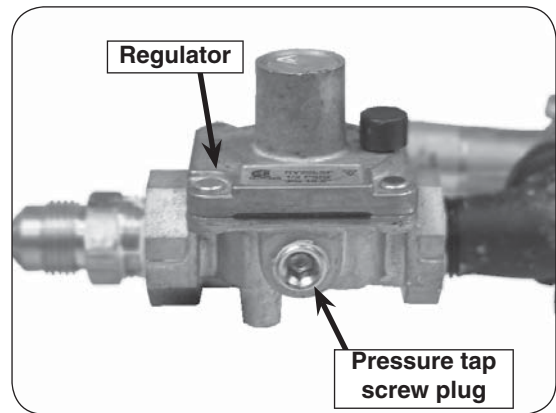

Fig. 20-2 Manual valve: check pressure

MANUAL VALVE

The pressure regulator is preset at the factory and locked to discourage tampering. If the pressure is not as specified, replace the regulator with the correct part from the PARTS LIST in this manual.

Remove the 1/8" pressure tap screw plug, located on the side of the regulator body. Install fitting and tubing of pressure gauge. After taking the pressure reading, re-install the pressure tap screw and check for leaks.

GAS PRESSURE SPECIFICATIONS

NATURAL GAS		PROPANE GAS	
Outlet pressure reading: (Flame adjustment on high)	3.5" w.c.	Outlet pressure reading: (Flame adjustment on high)	10" w.c.
Inlet pressure reading	Max. 10.5" w.c. Min. 5" w.c.	Inlet pressure reading	Max. 13" w.c. Min. 11" w.c.

LIGHTING INSTRUCTIONS - MANUAL VALVE

FOR YOUR SAFETY, READ BEFORE LIGHTING

WARNING: If you do not follow these instructions exactly, a fire or explosion may result, causing property damage, personal injury, or loss of life.

Do not use this appliance if any part has been underwater. Immediately call for a qualified professional service technician to inspect the appliance and to replace any part of the control system and any gas control that has been underwater.

The Real Fyre burner system has an ODS pilot. When starting the ODS pilot, follow these instructions exactly.

BEFORE LIGHTING, smell all around the gas burner system area for gas. Be sure to smell next to the floor as some gas is heavier than air and will settle on the floor. **IF YOU SMELL GAS, FOLLOW THE INSTRUCTIONS ON P. 1.**

Use only your hand to push in or turn the gas control knob. Never use tools. If the knob will not push in or turn by hand, don't try to repair it. Call a qualified professional service technician. Force or attempted repair may result in fire or explosion.

LIGHTING THE ODS PILOT

1. Push in the gas control knob (Fig. 21-1) slightly and turn clockwise ↻ to **OFF**.

Note: The burner control knob cannot be turned from **PILOT** to **OFF** unless the handle is pushed in slightly. Do not force.

2. Turn the control knob on the gas valve counterclockwise ↺ to **PILOT**.

Note: The burner control knob cannot be turned from **OFF** to **PILOT** unless the handle is pushed in slightly. Do not force.

Wait five minutes to clear out any gas. If you then smell gas, **STOP!** Notify your gas supplier or the fire department immediately. If you don't smell gas, go on to step 2.

3. Push in on the control knob all the way and hold in. Immediately light the ODS pilot with a long-neck butane lighter or press in ignitor button (Fig. 21-1) to light the ODS pilot. Continue to hold the control knob in for approximately 30 seconds after the ODS pilot is lit. Release the knob, and it will pop back out. The ODS pilot should remain lit. If it goes out, repeat steps 4 through 5.
- If the knob does not pop back out when released, stop and immediately call your service technician or gas supplier.
 - If the ODS pilot will not stay lit after several tries, follow the instructions for **SHUTTING OFF THE ODS PILOT** and call your service technician or gas supplier.

Manual valve system

Fig. 21-1

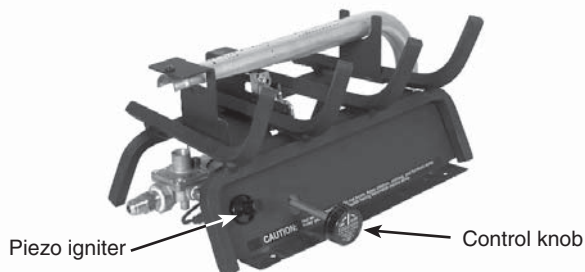

IGNITING THE MAIN BURNER

1. Push in slightly and rotate your manual control knob in a counterclockwise ↺ direction to the **ON/HIGH** position (first stop past **PILOT** position, see Fig. 21-2). The main burner will ignite at maximum BTU.

ADJUSTING THE FLAME HEIGHT

1. To lower the setting, push in slightly and continue to turn in a counterclockwise ↺ direction. When you reach the stop, your burner is at minimum **LOW** position.
2. To turn off *the main burners only*, push in slightly and rotate the manual control knob clockwise to the **PILOT** position. The **ODS pilot flame will remain lit**.

SHUTTING OFF THE ODS PILOT

If you do not intend to use your log set for an extended period of time, you may elect to turn the manual control knob to the **OFF** position. This will extinguish the ODS pilot. The next time you use the set, you will have to light the ODS pilot as described in **LIGHTING THE ODS PILOT**.

Note: When shutting your log set down, be sure to **TURN THE FLAME COMPLETELY TO THE OFF POSITION. Make sure the burner is completely off for one minute before relighting!**

If this unit was shipped with a remote, or if a remote system was installed later, read and follow the separate remote instructions to operate the burner remotely.

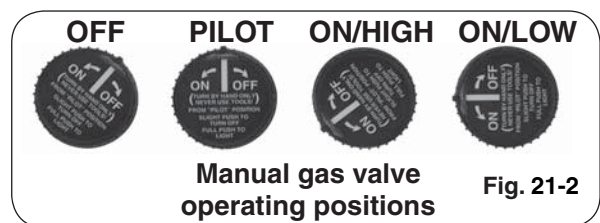

WARNING: NO ADJUSTMENTS ARE TO BE MADE TO THE ODS PILOT SYSTEM. TAMPERING WITH THIS SYSTEM CAN BE EXTREMELY HAZARDOUS.

LIGHTING INSTRUCTIONS - SERIES 12 VALVE

FOR YOUR SAFETY, READ BEFORE LIGHTING

WARNING

If you do not follow these instructions exactly, a fire or explosion may result, causing property damage, personal injury, or loss of life.

Do not use this appliance if any part has been underwater. Immediately call for a qualified professional service technician to inspect the appliance and to replace any part of the control system and any gas control that has been underwater.

The Real Fyre burner system has an ODS (Oxygen Depletion Sensor) pilot that can be lit by using the built in piezo igniter switch on the burner, or by hand using a match or long necked lighter. When lighting the ODS pilot, follow these instructions exactly.

BEFORE LIGHTING, smell all around the burner area for gas. Be sure to smell next to the floor as some gas is heavier than air and will settle on the floor. **IF YOU SMELL GAS, FOLLOW THE INSTRUCTIONS ON P. 1.**

Use only your hand to push in or turn the gas control knob. Never use tools. If the knob will not push in or turn by hand, don't try to repair it. Call a qualified professional service technician. Force or attempted repair may result in fire or explosion.

LIGHTING THE ODS PILOT

To read the safety valve control knob (Fig. 22-1), read the marking nearest the teardrop-shaped metal pointer.

1. If the safety valve control knob is in the **PILOT** position, push in slightly on the knob and rotate it clockwise ↻ to the **OFF** position.
2. Release knob and wait five minutes.
3. Turn safety valve knob counterclockwise ↻ to the **PILOT** position. (Only the ODS pilot gas will flow when the knob is pushed in.)
4. Push and hold the safety valve knob fully in and push in the piezo igniter button several times until the ODS pilot lights.
5. Hold the safety valve knob in for approximately 60 seconds before releasing.
6. **If the ODS pilot does not stay lit**, turn the safety valve knob clockwise ↻ to the full **OFF** position. Wait five minutes, then repeat steps 3 through 5.

IGNITING THE MAIN BURNER

With the ODS pilot lit, turn the safety valve knob counterclockwise ↻ to the **ON** position. Flip the switch control to the **ON** position and the burner will light. Refer to the PARTS LIST for the switch location.

SHUTTING OFF THE MAIN BURNER

Flip the switch control to the **OFF** position. The ODS pilot will remain lit.

SHUTTING OFF THE ODS PILOT

Be sure the switch control is **OFF** and depress and turn the safety valve knob clockwise ↻ to the **OFF** position.

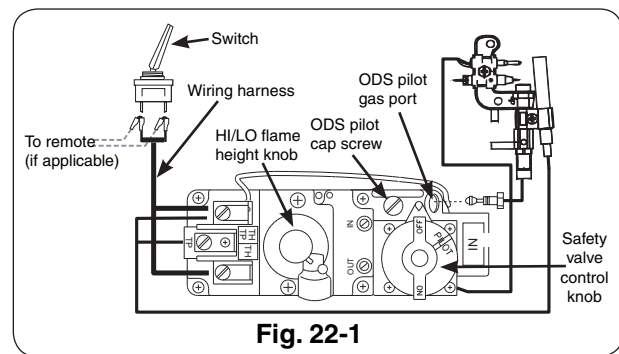

When shutting your burner down, be sure to **TURN THE FLAME FULLY OFF** (to **PILOT** or **OFF**). Make sure the burner is completely off for one minute before relighting.

ADJUSTING THE ODS PILOT

- a. The ODS pilot flame should encircle the generator tip, and is preset at the factory (Fig. 22-2). Ordinarily, the ODS pilot will not require field adjustment.
- b. If adjustment is necessary, remove the cap screw (Fig. 22-1) and turn the smaller gas adjustment screw inside counterclockwise ↻ to increase the ODS pilot flame, and clockwise ↻ to decrease the ODS pilot flame. Replace the cap screw.

MAINTENANCE

Your pan burner is equipped with a safety ODS pilot that will shut off the gas supply in case the ODS pilot is not burning or functioning properly. Make sure the ODS pilot is adjusted properly and that the generator spade clips are tightly connected to the terminal screws on the valve. If the ODS pilot will not stay lit, call your local gas utility or gas supplier.

A periodic check of the following should be performed at least annually by a qualified professional service representative:

1. Valves and switch for proper operation.
2. Flue system for rust, damage, or leaks.
3. Damper operation.
4. Orifices for dirt or other foreign matter.
5. Visual check on the burner.

If this unit was shipped with a remote, or if a remote system was installed later, read and follow the separate remote instructions to operate the burner remotely.

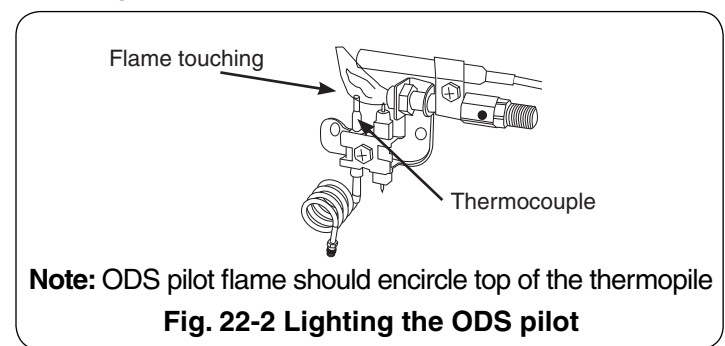

CLEANING AND SERVICING SAFETY INFORMATION

Note: Regular cleaning and servicing will be necessary to ensure proper ODS pilot operation and proper burn characteristics.

1. Always shut off the gas to the burner system while performing service work.
2. Allow the burner system to cool before servicing.
3. **Installation, service, and repair must be done by an NFI Certified or other qualified professional service technician. The appliance MUST be inspected before use, and cleaned at least annually to prevent burner shutdown, sooting, odors, etc. by a qualified professional service technician. It must be checked for clean burning operation and proper ODS pilot appearance, with the correct tools to service this unit. More frequent cleaning may be required.** Excessive lint can build up on this unit from carpeting, bedding material, pet hairs, or other particles in the air. It is imperative that all control components and compartments, burner, and circulating air passageways of the appliance be kept clean and free of all obstructions. The ODS pilot is especially sensitive to a dirty environment and will not function properly if dirty. Make certain all air openings are clean and free of obstructions, including:
 - a. The air intake openings on the ODS pilot assembly.
 - b. The ODS pilot opening.
 - c. The air shutter on the burner.

WARNING: Failure to keep the primary air openings of the burner clean may result in sooting and property damage.

- d. All of the ports on the burner. (See the CLEANING AND SERVICING section.)
4. **Any safety screen or guard removed for servicing must be replaced prior to operating this burner system.**
 5. **Do not use ammonia based or chlorinated cleaners when cleaning the log set.**

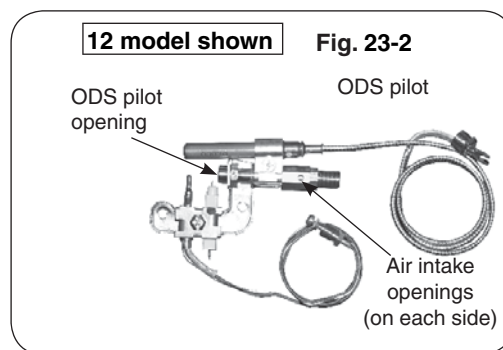
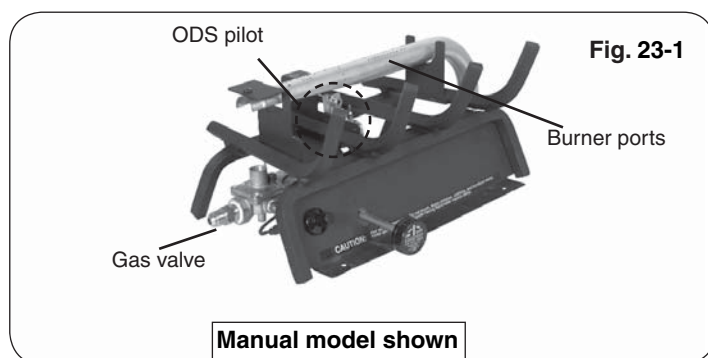

CLEANING AND SERVICING

Only limited cleaning will be required under normal use of the burner system.

TO CLEAN THE BURNER SYSTEM

1. Remove the log set. Use a vacuum cleaner to remove loose particles from all surfaces of the system. Do not use cleaning fluids.
2. Dust the assembly and the burner. Using a compressed air duster (commonly available at computer, electronic, or office supply stores) blow through all of the burner ports. See the burner figure on the previous page for locations.
3. Reinstall the log set.

If, after a period of use, the flames start to exhibit unusual shapes and behavior, or the burner fails to ignite smoothly, the burner ports may require some cleaning. If this happens, it is preferable to contact the nearest dealer to get the burner system serviced.

Do not remove the rating plates or the warning tags. These are an integral safety and identification component of this appliance.

During periods of heavy use, inspect the burner system frequently for evidence of sooting. If sooting is present, discontinue use until the source of sooting is corrected.

CLEANING AND SERVICING THE ODS PILOT

Periodic cleaning and maintenance of the burner system is recommended to ensure that the burner system operates properly. Cleaning of the ODS pilot system is an important part of the maintenance program.

This ODS pilot cleaning procedure must be performed by a qualified professional service technician familiar with the specific characteristics of the burner system.

1. Turn the burner system to the **OFF** position and allow it to cool. Inspect the ODS pilot area (see Fig. 24-1) for any visual contamination or debris (usually lint, hair, spider webs, or small insects). Lightly brush off all external surfaces while vacuuming loosened debris from the ODS pilot opening. **Be careful not to brush any foreign material into the ODS pilot opening.**

2. Clean out the air intake openings (see Fig. 24-1) by lightly brushing around the openings while vacuuming.

Note: It is very important that the air intake openings be kept clear of debris. Should the openings become blocked, the ODS pilot system will not operate properly.

3. Light the ODS pilot according to the relevant LIGHTING INSTRUCTIONS page. Periodically verify the ODS pilot flame appears as shown in the CHECKING THE ODS PILOT FLAME APPEARANCE section.
4. If the ODS pilot flame does not burn as indicated in the instructions, extinguish the ODS pilot by turning the valve to the full **OFF** position. Using a compressed air duster, insert the flexible nozzle through the air intake openings, ensuring that the nozzle is pointed toward the ODS pilot opening (see Fig. 24-1). Blow air through the intake openings to clear out any debris that may be in the system.
5. Relight the ODS pilot and inspect it to be sure it is burning as shown in the instructions. If not, extinguish the ODS pilot and **turn off the gas supply to the burner system.** Using an adjustable or a 1/4" wrench, disconnect the ODS pilot gas line (see Fig. 24-1) from the valve.
6. Insert the flexible nozzle of the compressed air duster and blow air into the input end of the ODS pilot gas line to remove any blockages. **Do not blow air directly into the ODS pilot opening. Blow air in the direction of the gas flow.**
7. Reinstall the ODS pilot gas line and check for leaks.
8. Light the ODS pilot to make sure it is operating properly (see LIGHTING INSTRUCTIONS).
9. If the ODS pilot still does not operate properly, the ODS pilot may need to be replaced with the same model as the one on the burner system.

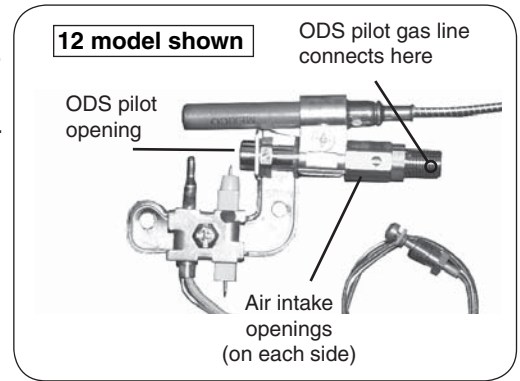

Fig. 24-1

SYNCING THE REMOTE SYSTEM (if equipped)

Ensure the burner system is off and completely cool.

Locate the 3-position switch on the remote receiver and slide it to the **REMOTE** position. Use the tip of a pen or a wire clip to push the **LEARN** button and release. See Fig. 25-1. A beep will be heard. Then press and hold the **ON** button on the remote transmitter; a series of beeps should be heard. The remote system is now synced. Light burner to test.

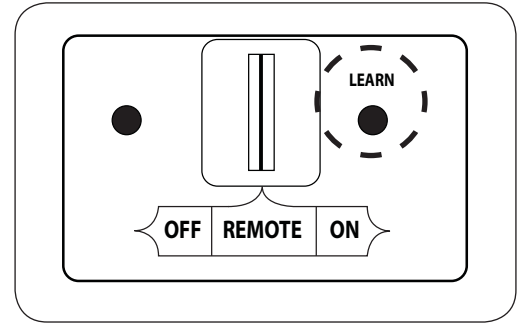

Fig. 25-1 Remote receiver sync detail

OPERATING THE BURNER SYSTEM

Observe the flames. The main burner flames should be blue at the base and a combination of blue/yellow at the body and at the tips. They should be 3" to 5" above the front logs. See Fig. 25-2.

Every Real Fyre burner system leaves the factory tested and quality checked to ensure that it has been manufactured to the strict specifications to which it was submitted and approved for certification. This check includes an operational test to ensure both satisfactory combustion and operation.

Each installation site for this appliance presents its own unique combustion environment. Specific factors such as weather-tightness of the home, size of the room in which the burner system is installed, central heating, ceiling fans, altitude, drafts, pet hair, carpet lint, dryer lint, the size of the fireplace, paint or soot inside the fireplace, etc. all have an influence on the proper operation of this appliance and its ODS pilot system. A normally operating burner system will demonstrate the following characteristics:

- A lively, realistic flame. The flame will be blue/yellow.
- Clean-burning combustion that will produce no soot or smoke after normal break-in.
- Production of no odor, other than normal odors associated with the combustion of propane or natural gas.
- Production of water vapor. Water vapor helps to increase indoor humidity, which may be beneficial during the dry heating season.

If you operate the burner system fueled by household propane gas, operating characteristics may vary as the fuel in the tank approaches empty. Sooting and other increases in combustion by-products will occur. Turn off the burner system and refill the propane tank.



Fig. 25-2

CHECKING THE ODS PILOT FLAME APPEARANCE

WARNING: NO ADJUSTMENTS ARE TO BE MADE TO THE ODS PILOT SYSTEM. TAMPERING WITH THIS SYSTEM CAN BE EXTREMELY HAZARDOUS.

When installing the burner assembly, it is important to visually check the ODS pilot flame and the burner flames.

1. The ODS pilot flame must be present when the burner is operating. The flame should touch the top of the thermocouple tip (Fig. 26-1 or Fig. 26-3).
2. If the ODS pilot flame does not touch the top of the thermocouple tip, then the main burner will not function properly (see Fig. 26-2 or Fig. 26-4 for incorrect ODS pilot flame).
3. With the burner off and the ODS pilot flame off, and the assembly cool, check the burner assembly, air intake openings on the ODS pilot, and air shutter openings on the burner for any blockages that could affect the operation of the ODS pilot flame.

ODS Pilot for Manual valve

(NG shown)

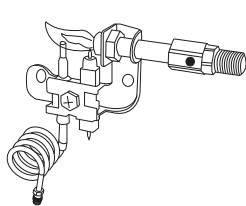

Correct ODS pilot flame

Fig. 26-1

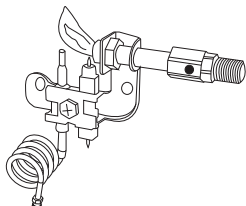

Incorrect ODS pilot flame

Fig. 26-2

ODS Pilot for 12 valve

(NG shown)

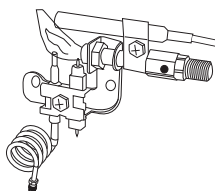

Correct ODS pilot flame

Fig. 26-3

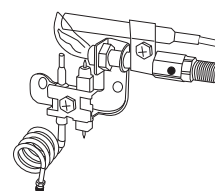

Incorrect ODS pilot flame

Fig. 26-4

TROUBLESHOOTING

- ONLY A QUALIFIED PROFESSIONAL SERVICE PERSON SHOULD SERVICE AND REPAIR THIS APPLIANCE.
- TURN OFF UNIT AND ALLOW TO COOL BEFORE TROUBLESHOOTING

1) BURNER SHUTTING DOWN DURING OPERATION

POSSIBLE CAUSE	SOLUTIONS
A. Insufficient or excessive gas pressure	<p>A1. Check gas pressure (Read E.- G. of IMPORTANT PRE-INSTALLATION AND FIREPLACE SAFETY INFORMATION section, & <u>check with local gas company</u>).</p> <p>A2. Other gas appliances may be on the same gas line, dropping gas pressure to the burner system. Check pressures with everything operating to ensure adequate pressure.</p>
B. Foreign debris in or around the fireplace and around the air intakes of the ODS pilot	B. Dust, carpet fibers, paper, spider webs, pet hair, etc. in fireplace or on burner assembly can affect operation of burner and ODS pilot assembly. Clean out debris and vacuum around burner for accumulated dust. Vacuum or use compressed air to clean out the ODS pilot assembly area, air shutter hole, burner orifice(s), and ODS pilot air intake openings. Blockage in this area will affect the operation of the ODS pilot assembly.
C. Room size (unconfined space)	C. 50 cu. ft. is required for every 1,000 BTU. Multiply the room's length x width x height by 20 (L x W x H x 20). If resulting number is less than the BTU rating of the burner, ODS pilot outages may occur. Provisions for adequate combustion and ventilation air must be made (see VENTILATION AND COMBINED SPACE SAFETY INFORMATION).
D. Flue area, fireplace, or damper dirty from soot	D. Clean around, above, and under damper thoroughly. Clean fireplace, removing loose material, including soot and creosote.
E. Fans, furnaces, air conditioning vents, returns, or fireplace outside air vents near or blowing into fireplace may create drafts, altering flame patterns	E. Eliminate drafts by closing heating and air conditioning vents, returns, and closing outside air vents. Fans blowing directly into the fireplace should be turned off when set is operating.
F. Blockages on burner	F. Vacuum any lava granules or material that may have fallen onto burner port area.
G. Fireplaces with high top cavities can accumulate by-products of combustion, which can start recirculating, causing shutdown	G. Open window or damper slightly. Move burner forward if possible, or otherwise increase ventilation.
H. Insufficient air circulation	H1. Check log placement, ember placement and sizing of burner system (check your owner's manual for proper placement and requirements). Reposition burner closer to the front of fireplace. (Note: Do not place burner too close to combustibles.) (See INSTALLATION SAFETY GUIDELINES section.)
	H2. Check for sunken fireplace, excessive lava granules, or other accessories packed too tightly against burner or high bottom lip on glass door. Open window or damper slightly.
I. Fireplace too small for unit	I. Ensure minimum requirements are met (see SPECIFICATIONS section).
J. At high altitude, too much heat or moisture can cause ODS pilot to shut down system	J. Open a window or the damper slightly or otherwise increase the ventilation. Your set may not be certified for use over 2,000 feet. Check your owner's manual.
K. ODS pilot flame lifting off thermocouple/generator	K. Check gas pressure (see section A1).
L. Pilot (remote-capable)	L. Contact your dealer for instructions on replacement.
M. Log placement	M. Reference the LOG SET PLACEMENT section in this manual for recommended log positioning.

TROUBLESHOOTING (Cont.)

POSSIBLE CAUSE

SOLUTIONS

2) ODS PILOT WILL NOT LIGHT

A. ODS pilot flame lifting off thermocouple/generator	A. Check gas pressure (see Section 1, A1 of this table).
B. Piezo spark not lighting ODS pilot	B. Check to make sure piezo is sparking when pressing / turning igniter. (Note: You may need to press / turn igniter several times to ignite ODS pilot.) See LIGHTING INSTRUCTIONS section.
C. Igniter electrode wire loose	C. Check wiring and reconnect any loose wiring
D. Igniter electrode positioned incorrectly	D. Contact your dealer for service
E. Gas supply off/manual shutoff valve closed	E. Turn on gas supply or open manual shutoff valve.
F. Air in gas line	F. Hold control knob to bleed the line and repeat LIGHTING INSTRUCTIONS until air is removed.
G. Pilot hood blocked	G. Check for debris or dirt / Clean pilot
H. Dead batteries (if applicable)	H. Replace batteries as needed.

3) HIGH CO - CARBON MONOXIDE DETECTORS IN HOME TURNING ALARM ON

A. High CO levels	A. TURN OFF UNIT IMMEDIATELY. Call a qualified professional service technician or your gas supplier.
-------------------	---

4) CONDENSATION

A. High room humidity and cold walls or windows will create condensation in room	A. Open a window or damper slightly.
--	--------------------------------------

5) LOW FLAME HEIGHT

A. Low gas pressure	A. Check gas pressure (see Section 1, A1 of this table).
B. Household propane tank running low	B. Fill Tank completely.
C. Supply valve not fully open	C. Open supply valve fully.
D. Blockage or kink in flex connector kit, plumbing, or burner orifice	D. Clean out blockage. If flex connector is kinked, replace it.
E. Remote set on low flame (if option available)	E. Adjust flame with remote transmitter.

6) BURNER NOT BURNING EVENLY

A. Burner ports clogged	A. Clean burner ports.
-------------------------	------------------------

7) ODORS

A. New burner system (break-in period)	A. Burn unit for four to six hours with damper, doors, or windows open. Allow odors to dissipate.
B. Odors created by aerosol sprays, detergents, household chemicals, insecticides, new home, new carpet, or new paint	B. When these odors are drawn into the fireplace, this may cause objectionable odors. Thoroughly ventilate the area before restarting your burner system.
C. Gas leak	C. Shut off gas, if possible. Follow instructions on front page. Have a qualified professional service technician or the gas company correct all leaks.

TROUBLESHOOTING (Cont.)

POSSIBLE CAUSE	SOLUTIONS
8) SOOTING	
A. Low gas pressure	A. Check gas pressure (see Section 1, A1 of this table).
B. Drafts in room	B. Eliminate drafts by closing heating and air conditioning vents, returns, and outside air vents. Fans blowing directly into fireplace should be turned off when system is operating.
C. Air shutter(s) blocked	C. Burner air shutter(s) are blocked with debris. Vacuum debris in and around burner area.
D. Using a product other than Real Fyre gas logs with burner	D. Make sure only Real Fyre <u>vent-free</u> gas logs are used with your vent-free burner.
E. Using natural gas burner on propane gas or propane burner on natural gas	E. If gas listed on nameplate does not match gas you are burning, shut down burner system immediately. Call dealer.
F. Adding any accessories to burner system	F. Shut down burner system and take off any accessories that do not belong with the system.
G. Blocked orifice(s) or air shutter(s)	G. Dust, lint, fibers, paper, spider webs, pet hair, etc. in the fireplace and on the burner assembly can affect the operation of the burner and the ODS pilot assembly. Clean out the debris and vacuum around burner for dust that may have accumulated over time. Vacuum the ODS pilot assembly and over the air shutter holes. Any blockages in this area will affect the operation of the ODS sensor. Remove and clean venturi tube if applicable.
H. Improper media placement	H. See INSTALLATION section for proper media placement.
I. Log placement	I. Reference the LOG SET PLACEMENT section in this manual for recommended log positioning.
9) ODS PILOT WILL NOT STAY LIT	
A. Haven't pressed and held knob in long enough (if applicable)	A. Hold knob in for 1 minute and release. If the knob doesn't hold, contact your dealer for service (valve replace or new ODS).
B. Valve won't hold	B. Contact your dealer for instructions on replacement.
C. Pilot line bent / kinked at connection to valve	C. Replace pilot line.
D. Thermocouple is loose	D. Tighten thermocouple nut at gas control valve. (Do not over tighten.)
E. Thermocouple cracked or worn out	E. Replace thermocouple.
10) WHISTLING NOISE COMING FROM BURNER	
A. Burner may be cold or may have not been used for a prolonged period of time	A. Allow burner to warm up on low.
B. Air in gas line	B. Contact your gas company.
C. Clogged air openings	C. Clean all air openings.
11) BURNER WILL NOT TURN ON	
A. Low/dead batteries (if applicable)	A. Replace batteries as needed.
12) FLAME AT AIR MIX / ORIFICE (PROPANE MODELS)	
A. Burner ports clogged	A. Clean burner ports.
B. Gas pressure	B. Check gas pressure (see Section 1, A1 of this table).
<p>WARNING: If the gas quality is bad, the burners will produce soot and/or your pilot will not stay lit. Contact your gas company.</p>	

WARRANTY

PETERSON UNVENTED ROOM HEATER GAS APPLIANCE LIMITED WARRANTY

Robert H. Peterson Co. ("RHP") warrants your Real Fyre® unvented room heater gas appliance to be free from defects in material and workmanship.

Peterson unvented ceramic refractory gas logs are warranted for **as long as you own them (lifetime)**.

Peterson unvented burner component parts, except valves, ODS pilots, and controls, are warranted for **TEN (10) YEARS**. Peterson unvented outdoor stainless-steel burners are warranted for **FIVE (5) YEARS**.

Peterson glass, gems, and nuggets are warranted for **FIVE (5) YEARS**.

All Peterson valves, ODS pilots, and controls are warranted for **ONE (1) YEAR (excluding batteries)**.

A COPY OF YOUR SALES SLIP FOR PROOF OF PURCHASE IS REQUIRED

This warranty applies to the original purchaser for products which are installed in the United States or Canada and which are operated and maintained as intended for single family residential usage. This warranty is valid only with proof of purchase, shall commence on the date of purchase, and shall terminate (both as to original and any replacement products) on the anniversary date of the original purchase of the product stated on the above schedules.

This warranty covers defects in material and workmanship. This warranty **does not** cover parts which become defective as a result of negligence, misuse, use not in compliance with the Owner's Manual/Installation Instructions, accidental damage, improper handling, improper storage, improper installation, **lack of required routine maintenance** (as specified in the Owner's Manual/Installation Instructions), electrical damage, local gas impurities or failure to protect against combustibles. Product must be installed (and gas must be connected) as specified in the Owner's Manual/Installation Instructions by a **qualified professional installer**. Modifications to products which are not specifically authorized will void this warranty. Accessories, parts, valves, remotes, etc. when used must be Peterson products or this warranty is void. Warranted items will be repaired or replaced at Peterson's sole discretion. This warranty **does not** apply to rust, corrosion, oxidation, or discoloration unless the affected part becomes inoperable.

This warranty **does not** cover labor or labor related charges, except as provided by separate specific written programs from the Peterson Co. All repair work must be performed by a qualified professional service person and requires prior approval of Peterson.

Peterson may require the defective product or part to be returned to the factory to determine the cause of failure. Peterson will pay freight charges if the product or part is determined to be defective. This warranty does not cover breakage in shipment from our (Independent) distributor to its customer if the damage is determined to have occurred during that shipment.

This warranty specifically excludes liability for **indirect, incidental, or consequential** damages. Some states and provinces do not allow the exclusion or limitation of incidental or consequential damages, so the above exclusion may not apply to you. This warranty gives you specified legal rights, and you may have other rights that vary from state to state or province.

For additional information regarding this warranty, or to place a warranty claim, contact the R. H. Peterson dealer where the product was purchased.

When contacting your Peterson dealer or the R. H. Peterson Co., please provide the following information:

- Your name, address, telephone number, e-mail
- Sales receipt showing where purchased and date purchased
- Model number, serial number of product, date code
- Relevant information: installer, additions, repairs, when defect was first noted

**TO REGISTER YOUR PRODUCT ONLINE GO TO: WWW.RHPETERSON.COM,
AND CLICK ON PRODUCT REGISTRATION. THANK YOU FOR YOUR PURCHASE.**

WHEN USED IN THE COMMONWEALTH OF MASSACHUSETTS

**INSTALLATION OF THIS APPLIANCE MUST BE PERFORMED BY A MASSACHUSETTS LICENSED PLUMBER
OR GAS FITTER ONLY.**

**THE INSTALLATION OF THIS APPLIANCE MUST BE IN COMPLIANCE WITH 527 CMR AND 248 CMR: BOARD OF
STATE EXAMINERS OF PLUMBERS AND GAS FITTERS.**

**This unvented gas appliance is designed for use in a standard wood-burning fireplace. It is designed to be used
with an external wall switch or external remote thermostatic control system. Models with the suffix 12(P), 15(P), or
01V(P) are designed to be used with an external wall switch or an external remote wall thermostatic control system.**

Quality Check

Date: _____

Burner Orifices	Nat.	L.P.	Leak Test:	_____	Model#:	_____
Main:	_____	_____	Burn Test:	_____	Serial#:	_____
Other:	_____	_____	Gas Type:	<u>Nat. / L.P.</u>	Air Shutter:	_____
					Inspector:	_____